

OWNER'S MANUAL

AIR CONDITIONER

Please read this manual carefully before operating your set and retain it for future reference.

4-WAY CEILING CASSETTE, CEILING CONCEALED DUCT
Original instruction (R32)

[Representative] LG Electronics Inc. EU Representative :

LG Electronics European Shared Service Center B.V.
Krijgsman 1, 1186 DM Amstelveen, The Netherlands

[Manufacturer] LG Electronics Inc. Changwon 2nd factory 84, Wanam-ro,
Seongsan-gu, Changwon-si, Gyeongsangnam-do, KOREA



TIPS FOR SAVING ENERGY

Here are some tips that will help you minimize the power consumption when you use the air conditioner. You can use your air conditioner more efficiently by referring to the instructions below:

- Do not cool excessively indoors. This may be harmful for your health and may consume more electricity.
- Block sunlight with blinds or curtains while you are operating the air conditioner.
- Keep doors or windows closed tightly while you are operating the air conditioner.
- Adjust the direction of the air flow vertically or horizontally to circulate indoor air.
- Speed up the fan to cool or warm indoor air quickly, in a short period of time.
- Open windows regularly for ventilation as the indoor air quality may deteriorate if the air conditioner is used for many hours.
- Clean the air filter once every 2 weeks. Dust and impurities collected in the air filter may block the air flow or weaken the cooling / dehumidifying functions.

For your records

Staple your receipt to this page in case you need it to prove the date of purchase or for warranty purposes. Write the model number and the serial number here:

Model number : _____





Serial number : _____

You can find them on a label on the side of each unit.

Dealer's name : _____

Date of purchase : _____

IMPORTANT SAFETY INSTRUCTIONS

	Read the precautions in this manual carefully before operating the unit.		This appliance is filled with flammable refrigerant (R32)
	This symbol indicates that the Operation Manual should be read carefully.		This symbol indicates that a service personnel should be handling this equipment with reference to the Installation Manual.

READ ALL INSTRUCTIONS BEFORE USING THE APPLIANCE.

Always comply with the following precautions to avoid dangerous situations and ensure peak performance of your product

⚠ WARNING

It can result in serious injury or death when the directions are ignored

⚠ CAUTION

It can result in minor injury or product damage when the directions are ignored. This appliance is intended to be used by expert or trained users in shops, in light industry and on farms, or for commercial use by lay persons.

⚠ WARNING

- Always ground the product. There is a risk of electric shock.
- Do not use a defective or underrated circuit breaker. Use the correctly rated breaker and fuse. There is risk of fire or electric shock.
- Do not use a multi consent. Always use this appliance on a dedicated circuit and breaker. Otherwise it can cause electric shock or fire.
- For electrical work, contact the dealer, seller, a qualified electrician, or an Authorized Service Center. Do not disassemble or repair the product by yourself. There is risk of fire or electric shock.
- Always ground the product as per the wiring diagram. Do not connect the ground wire to gas or water pipes lightning rod or telephone ground wire. There is risk of fire or electric shock.

- Install the panel and the cover of control box securely. There is risk of fire or electric shock due to dust, water etc.
- Use the correctly rated breaker or fuse. There is risk of fire or electric shock.
- Do not modify or extend the power cable. If the power cable or cord has scratches or skin peeled off or deteriorated then it must be replaced. There is risk of fire or electric shock.
- For installation, removal or reinstall, always contact the dealer or an Authorized Service Center. There is risk of fire, electric shock, explosion, or injury.
- Do not install the product on a defective installation stand. Be sure that the installation area does not deteriorate with age. It may cause product to fall.
- Never install the outdoor unit on a moving base or a place from where it can fall down.
The falling outdoor unit can cause damage or injury or even death of a person.
- When the product is soaked (flooded or submerged) in water, contact an Authorized Service Center for repair before using it again. There is risk of fire or electric shock.
- Be sure to check the refrigerant to be used. Please read the label on the product. Incorrect refrigerant used can prevent the normal operation of the unit.
- Don't use a power cord, a plug or a loose socket which is damaged. Otherwise it may cause a fire or electrical shock.
- Do not touch, operate, or repair the product with wet hands. Hold the plug by hand when taking out. There is risk of electric shock or fire.
- Do not place a heater or other heating appliances near the power cable. There is risk of fire and electric shock.
- Do not allow water to run into electric parts. Install the unit away from water sources. There is risk of fire, failure of the product, or electric shock.
- Do not store or use or even allow flammable gas or combustibles near the product. There is risk of fire.

- Indoor/outdoor wiring connections must be secured tightly and the cable should be routed properly so that there is no force pulling the cable from the connection terminals. Improper or loose connections can cause heat generation or fire.
- Safely dispose off the packing materials. Like screws, nails, batteries, broken things etc after installation or svc and then tear away and throw away the plastic packaging bags. Children may play with them and cause injury.
- Make sure to check that the power cable plug is not dirty, loose or broken and then only insert the plug completely. Dirty, loose or broken power plug can cause electric shock or fire.
- In outdoor unit the step-up capacitor supplies high voltage electricity to the electrical components. Be sure to discharge the capacitor completely before conducting the repair work. An charged capacitor can cause electrical shock.
- When installing the unit, use the installation kit provided with the product. Otherwise the unit may fall and cause severe injury.
- Be sure to use only those parts which are listed in the svc parts list. Never attempt to modify the equipment. The use of inappropriate parts can cause an electrical shock, excessive heat generation or fire.
- Do not use the product in a tightly closed space for a long time. Perform ventilation regularly. Oxygen deficiency could occur and hence harm your health.
- Do not open the front grille of the product during operation. (Do not touch the electrostatic filter, if the unit is so equipped.) There is risk of physical injury, electric shock, or product failure.
- If strange sounds, smell or smoke comes from product. Immediately turn the breaker off or disconnect the power supply cable. There is risk of electric shock or fire.
- Ventilate the product room from time to time when operating it together with a stove, or heating element etc. Oxygen deficiency can occur and hence harm your health.
- Turn the main power off and unplug the unit when cleaning or repairing the product. There is risk of electric shock.

- When the product is not to be used for a long time, disconnect the power supply plug or turn off the breaker. There is risk of product damage or failure, or unintended operation.
- Take care to ensure that nobody especially kids could step on or fall onto the outdoor unit. This could result in personal injury and product damage.
- Take care to ensure that power cable could not be pulled out or damaged during operation. There is risk of fire or electric shock.
- Do not place ANYTHING on the power cable. There is risk of fire or electric shock.
- Do not plug or unplug the power supply plug to turn the unit ON/OFF. There is risk of fire or electric shock.
- When flammable gas leaks, turn off the gas and open a window for ventilation before turn the product on. Do not use the telephone or turn switches on or off. There is risk of explosion or fire.
- Do not turn on the breaker or power under condition that front panel, cabinet, top cover, control box cover are removed or opened. Otherwise, it may cause fire, electric shock, explosion or death.
- Use a vacuum pump or Inert (nitrogen) gas when doing leakage test or air purge. Do not compress air or Oxygen and Do not use Flammable gases. Otherwise, it may cause fire or explosion. There is the risk of death, injury, fire or explosion.
- The appliance shall be stored in a room without continuously operating ignition sources (for example : open flames, an operating gas appliance or an operating electric heater.)
- Keep any required ventilation openings clear of obstruction.
- The appliance shall be stored in a well-ventilated area where the room size corresponds to the room area as specified for operation.
- Ducts connected to an appliance shall not contain an ignition source.

 **CAUTION**

- Two or more people must lift and transport the product. Avoid personal injury.
- Do not install the product where it will be exposed to sea wind (salt spray) directly. It may cause corrosion on the product.
- Install the drain hose to ensure that the condensed water is drained away properly. A bad connection may cause water leakage.
- Keep level even when installing the product. To avoid vibration or noise.
- Do not install the product where the noise or hot air from the outdoor unit could damage or disturb the neighborhoods. It may cause a problem for your neighbors and hence dispute.
- Always check for gas (refrigerant) leakage after installation or repair of product. Low refrigerant levels may cause failure of product.
- Do not use the product for special purposes, such as preserving foods, works of art, etc. It is a consumer air conditioner, not a precision refrigeration system. There is risk of damage or loss of property.
- Do not block the inlet or outlet of air flow. It may cause product failure.
- Use a soft cloth to clean. Do not use harsh detergents, solvents or splashing water etc. There is risk of fire, electric shock, or damage to the plastic parts of the product.
- Do not touch the metal parts of the product when removing the air filter. There is risk of personal injury.
- Do not step on or put anything on the product. (outdoor units) There is risk of personal injury and failure of product.
- Always insert the filter securely after cleaning. Clean the filter every two weeks or more often if necessary. A dirty filter reduces the efficiency.
- Do not insert hands or other objects through the air inlet or outlet while the product is operating. There are sharp and moving parts that could cause personal injury.

- Be cautious when unpacking and installing the product. Sharp edges could cause injury.
- If the refrigerant gas leaks during the repair, do not touch the leaking refrigerant gas. The refrigerant gas can cause frostbite (cold burn)
- Do not tilt the unit when removing or uninstalling it. The condensed water inside can spill.
- Do not mix air or gas other than the specified refrigerant used in the system. If air enters the refrigerant system, an excessively high pressure results, causing equipment damage or injury.
- If the refrigerant gas leaks during the installation, ventilate the area immediately. Otherwise it can be harmful for your health.
- Dismantling the unit, treatment of the refrigerant oil and eventual parts should be done in accordance with local and national standards.
- Replace the all batteries in the remote control with new ones of the same type. Do not mix old and new batteries or different types of batteries. There is risk of fire or product failure.
- Do not recharge or disassemble the batteries. Do not dispose off batteries in a fire. They may burn or explode.
- If the liquid from the batteries gets onto your skin or clothes, wash it well with clean water. Do not use the remote if the batteries have leaked. The chemicals in batteries could cause burns or other health hazards.
- If you eat the liquid from the batteries, brush your teeth and see doctor.
Do not use the remote if the batteries have leaked. The chemicals in batteries could cause burns or other health hazard.
- Do not let the air conditioner run for a long time when the humidity is very high and a door or a window is left open. Moisture may condense and wet or damage furniture.
- Do not expose your skin or kids or plants to the cool or hot air draft. This could harm to your health.
- Do not drink the water drained from the product. It is not sanitary and could cause serious health issues.

- Use a firm stool or ladder when cleaning, maintaining or repairing the product at an height. Be careful and avoid personal injury.
- The air conditioner is not intended for use by young children or invalids without supervision.
- Young children should be supervised to ensure that they do not play with the air conditioner.
- The appliance shall be stored so as to prevent mechanical damage from occurring.
- Any person who is involved with working on or breaking into a refrigerant circuit should hold a current valid certificate from an industry-accredited assessment authority, which authorises their competence to handle refrigerants safely in accordance with an industry recognised assessment specification.
- Servicing shall only be performed as recommended by the equipment manufacturer. Maintenance and repair requiring the assistance of other skilled personnel shall be carried out under the supervision of the person competent in the use of flammable refrigerants.
- Wear adequate personal protection equipment (PPE) when installing, maintaining or servicing the product.
- This appliance can be used by children aged from 8 years and above and persons with reduced physical, sensory or mental capabilities or lack of experience and knowledge if they have been given supervision or instruction concerning use of the appliance in a safe way and understand the hazards involved. Children shall not play with the appliance. Cleaning and user maintenance shall not be made by children without supervision.
- This appliance is not intended for use by persons (including children) with reduced physical, sensory or mental capabilities or lack of experience and knowledge, unless they have been given supervision or instruction concerning use of the appliance by a person responsible for their safety. Children should be supervised to ensure that they do not play with the appliance.

TABLE OF CONTENTS

2 TIPS FOR SAVING ENERGY

3 IMPORTANT SAFETY INSTRUCTIONS

12 BEFORE USE

- 12 About the system
- 12 Preparing for operation
- 12 Usage
- 12 Cleaning and maintenance
- 12 Service
- 12 Disposal

13 PRODUCT INTRODUCTION

- 13 Name and function of parts (4-WAY CEILING CASSETTE)
- 13 Name and function of parts (CEILING CONCEALED DUCT)
- 14 Operation Indicator Lamp
- 15 Wired Remote Controller
- 16 Wireless Remote Controller (Accessory)

17 OPERATING INSTRUCTIONS

- 17 Standard Operation - Standard Cooling
- 18 Standard Operation - Power Cooling
- 18 Standard Operation - Heating Mode
- 19 Standard Operation - Dehumidification Mode
- 19 Auto Changeover Mode
- 20 Standard Operation - Fan Mode
- 21 Standard Operation - Auto Operation Mode
- 22 Standard Operation - Airflow Setting
- 23 Standard Operation - Temperature Setting/Room Temperature Check
- 24 Sub Function - Plasma Purification(Accessory)
- 25 Sub Function - Comfort Cooling
- 25 Function Setting - Child Lock
- 26 Function Setting - Change Temp
- 27 Function Setting - Elevation Grill(Accessory)
- 28 Function Setting - Filter Sign Clear
- 29 Function Setting - Vane Angle Control
- 30 Function Setting - Changing Current Time
- 32 Programming - Simple Reservation

33	Programming - Weekly Reservation
35	Programming - Sleep Reservation
36	Programming - ON Reservation
38	Programming - OFF Reservation
40	Programming - Holiday Reservation

41 MAINTENANCE AND SERVICE

41	Indoor Unit
42	Purifying filter(Optional)
43	Operation Tips!
43	When the air conditioner is not going....
44	Troubleshooting Tips! Save time and money!
44	Call the service immediately in the following situations

BEFORE USE

About the system

This system of air conditioner can be used for heating/cooling applications.

Preparing for operation

- Contact an installation specialist for installation.
- Use a dedicated circuit.

Usage

- Being exposed to direct airflow for an extended period of time could be hazardous to your health. Do not expose occupants, pets, or plants to direct airflow for extended periods of time.
- Due to the possibility of oxygen deficiency, ventilate the room when used together with stoves or other heating devices.
- Do not use this air conditioner for non-specified special purposes (e.g. preserving precision devices, food, pets, plants, and art objects). Such usage could damage the items.

Cleaning and maintenance

- Do not touch the metal parts of the unit when removing the filter. Injuries can occur when handling sharp metal edges.
- Do not use water to clean inside the air conditioner. Exposure to water can destroy the insulation, leading to possible electric shock.
- When cleaning the unit, first make sure that the power and breaker are turned off. The fan rotates at a very high speed during operation. There is a possibility of injury if the unit's power is accidentally triggered on while cleaning inner parts of the unit.

Service

For repair and maintenance, contact your authorized service dealer.

Disposal

The unit uses hydrofluorocarbon. Contact your dealer when discarding this unit. It is required by law to collect, transport and discard the refrigerant in accordance with the "hydrofluorocarbon collection and destruction" regulations.

PRODUCT INTRODUCTION

Name and function of parts (4-WAY CEILING CASSETTE)

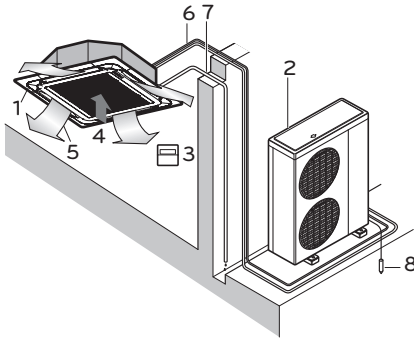

- 1: Indoor unit
- 2: Outdoor unit
- 3: Remote controller
- 4: Inlet air
- 5: Discharge air
- 6: Refrigerant piping, connection electric wire
- 7: Drain pipe
- 8: Ground wire
Wire to ground outdoor unit to prevent electrical shocks.

Name and function of parts (CEILING CONCEALED DUCT)

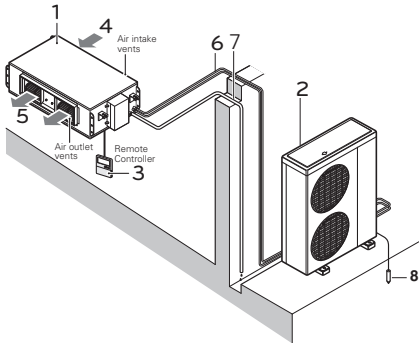

- 1: Indoor unit
- 2: Outdoor unit
- 3: Remote controller
- 4: Inlet air
- 5: Discharge air
- 6: Refrigerant piping, connection electric wire
- 7: Drain pipe
- 8: Ground wire
wire to ground outdoor unit to prevent electrical shocks.

Operation Indicator Lamp

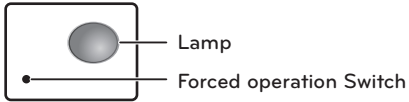

Description	Lamp Color
Cooling mode	Green
Heating mode	Green
Time to clean filter in cooling/heating Mode	Yellowish Green
Time to clean filter when product is not operating	Orange
Hot start or defrost mode before starting heating mode	Green
When reservation set on	Yellowish Green

Wired Remote Controller

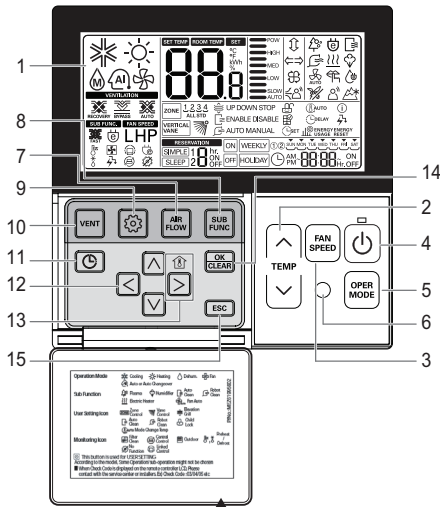

- 1 OPERATION INDICATION SCREEN
- 2 SET TEMPERATURE Button
- 3 FAN SPEED Button
- 4 ON/OFF Button
- 5 OPERATION MODE SELECTION Button
- 6 WIRELESS REMOTE CONTROLLER RECEIVER
 - Some products don't receive the wireless signals.
- 7 AIR FLOW Button
- 8 SUBFUNCTION Button
- 9 FUNCTION SETTING Button
- 10 VENTILATION Button
- 11 RESERVATION
 - To check the indoor temperature, press  button.
- 13 ROOM TEMPERATURE Button
- 14 SETTING/CANCEL Button
- 15 EXIT Button

Please attach the inform label inside of the door.
Please choose proper language depend on your country.

* Some functions may not be operated and displayed depending on the product type.

! NOTE

- Display temperature can be different from actual room temperature if the remote controller is installed at the place where sun-rays are falling directly or the place nearby heat source.
- The actual product can be different from above contents depending upon model type.
- When using simultaneous operation system, whenever press remote controller button, system will approximately operate after 1~2 minutes.

Wireless Remote Controller (Accessory)

This air-conditioner is equipped with wired remote controller basically. But if you want to be available with wireless remote controller, you pay for it.

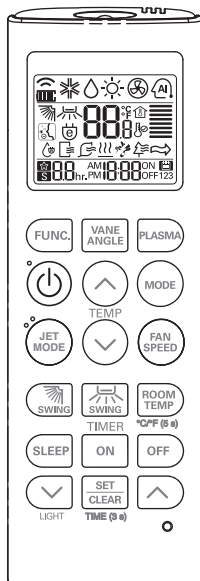

PQWRHQ0FDB

! CAUTION

CAUTION of handling the Remote Controller

- Aim at the signal receiver on the wired remote controller so as to operate.
- The remote control signal can be received at a distance of up to about 7m.
- Be sure that there are no obstructions between the remote controller and the signal receptor.
- Do not drop or throw the remote controller.
- Do not place the remote controller in a location exposed to direct sunlight, or near the heating unit, or any other heat source.
- Block a strong light over the signal receptor with a curtain or etc. so as to prevent the abnormal operation. (ex:electronic quick start, ELBA, inverter type fluorescent lamp)

! NOTE

- The wireless remote controller do not operate the vane angle control.(4Way Type)
- For more details refer to the Wireless Remote Control Accessory manual.
- The actual product can be different from above contents depending upon model type.
- The wireless remote controller does not operate When using simultaneous operation system.

OPERATING INSTRUCTIONS

Standard Operation - Standard Cooling

It cools the room by comfortable and clean wind.

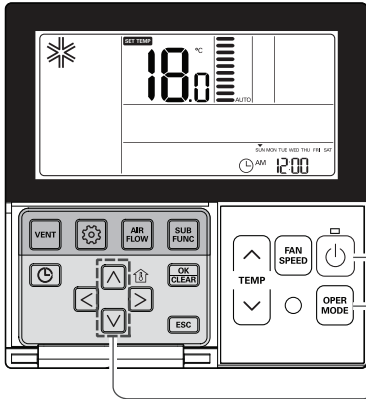



1 Press  button to turn on the indoor.



2 Press  button to select Cooling operation mode.





3 Adjust the desired temperature by pressing   buttons. Press  button to check the Room temperature. When setting the desired temperature higher than room temperature, only ventilation wind is blow out instead of cooling wind.

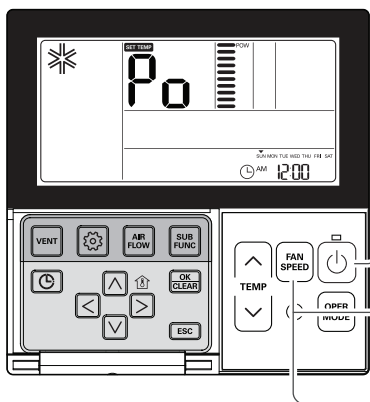

Standard Operation - Power Cooling

It makes the room cool using pleasant and fresh air quickly.



1 Press  button to turn on the indoor.



2 Press  button to select cooling operation mode.



3 Press  button continuously until 'Po' displayed.



What is Power Cooling?

- Desired temperature: Po (actually 18°C)
- Wind flow: power wind
- Wind direction: fix to air-cooling position

} It make room temperature drop fast by running

* Partial product has no power air-cooling function.

Standard Operation - Heating Mode

It supplies warm wind to the indoor.

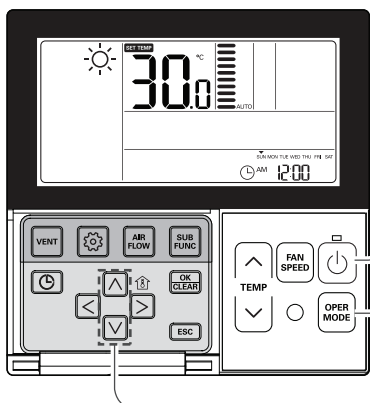

1 Press  button to turn on the indoor.



2 Press  button to select Heating mode.
(To check the indoor temperature, press the room temperature button.)



3 Adjust the desired temperature by pressing   buttons.







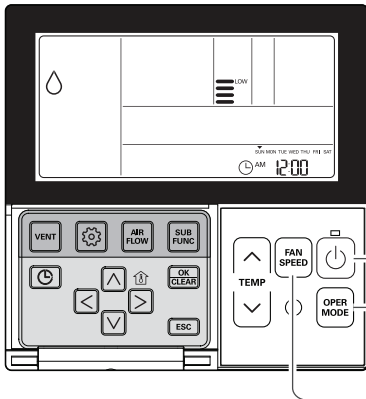

When setting the desired temperature lower than room temperature, there is only ventilation wind.

- Heating drive only operates at the cooling and heating model.
- Heating doesn't operate at cooling exclusive model.

Standard Operation - Dehumidification Mode





It removes humidity while air-cooling weakly.



- 1 Press  button to turn on the indoor. 
- 2 Press  button to select Dehumidification mode. The temperature setting can not be adjusted during operation this mode. 
- 3 Press the  button to select airflow rate feeble → weak → medium → strong → automatic. (The initial wind powerfulness of humidity removal drive is 'weak'.) 

- In rainy season or high humidity climate, it is possible to operate simultaneously dehumidifier and cooling mode to remove humidity effectively.
- The menu item of wind powerfulness might not be partially selected according to the product.

Auto Changeover Mode

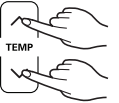
- 1 Press  button to turn on the indoor. 
- 2 Press  button to select Auto Changeover Mode. 
- 3 The setting temperature as the right side picture can be set in both cooling/ heating model. 

Standard Operation - Fan Mode

It blows the air as it is in the indoor, not the cold wind.

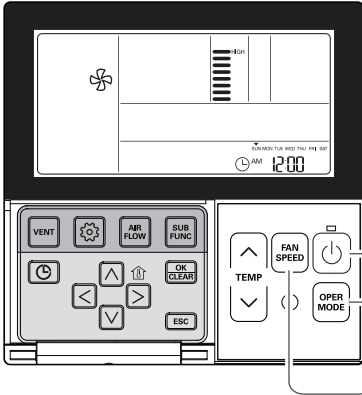

1 Press  button to turn on the indoor.



2 Press  button to select Fan Mode.





3 Every time pressing  button, you can select wind flow in order of feeble → weak → medium → strong → automatic.
When running ventilation, compressor of AHU doesn't work.

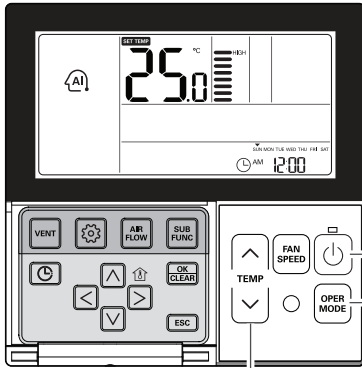

- Ventilation drive does not release cool wind but general fan
- Because it releases the wind that has no temperature difference from the room, it functions to circulate the inside air.
- The menu item of wind powerfulness might not be partially selected according to the product.

Standard Operation - Auto Operation Mode



1 Press  button to turn on the indoor.



2 Press  button to select Artificial intelligence Mode.



3 You can adjust the temperature as the picture on the right for cooling and heating model.



4 For the case of cooling exclusive, as the picture on the right, you can adjust the temperature from hot to cold, from "-2" to "2" based on "00".

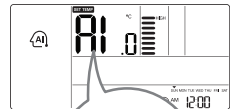

- 2 When cold
1 When cool
0 When appropriate
- 1 When warm
- 2 When hot

During operating Auto Operation mode:

- We can use the FAN SPEED button
- We can change manually to other operation mode.

Standard Operation - Airflow Setting

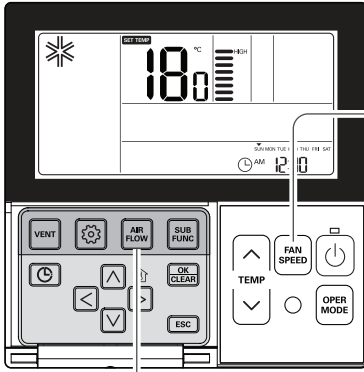



Wind powerfulness : You can simply adjust desired wind powerfulness.

- 1 Please setup desired wind powerfulness by wind powerfulness button.
 - Every time you press wind powerfulness, you can select the wind flow in order of 'feeble → weak → weak medium → medium → medium strong → strong → power → automatic'.
 - The menu item might not be partially selected according to product function.



Wind direction : You can simply adjust desired wind direction.

- 1 Please set desired wind direction by pressing  button. You can select wind direction of (comfortable wind → Up/Down and Right/Left → Right/Left → Up/Down) by pressing  button. Partial item of wind directions might not be selected according to product function.



* Some functions may not be operated and displayed depending on the product type.

Standard Operation - Temperature Setting/Room Temperature Check

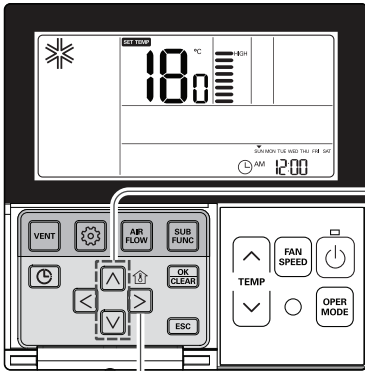

Temperature Setting

- 1 We can simply adjust the desired temperature.
 - Press the buttons to adjust the desired temperature.

- : Increase 1°C or 2°F per one time pressing
- : Decrease 1°C or 2°F per one time pressing

- Room temp: Indicate the current room temperature.
- Set temp: Indicate the temperature that user want to set.
- * Depend on what kind of controller, the desired temperature can be adjusted at 0.5°C or 1°F.

Cooling operation:

- The cooling mode doesn't work if desired temperature is higher than room temperature. Please lower the desired temperature.

Heating operation:

- The heating mode doesn't work if desired temperature is lower than room temperature. Please increase the desired temperature.

Room Temperature Check

- 1 Whenever press button, the room temperature will be displayed within 5 seconds.
After 5 seconds, it turns to display the desired temperature.
Because of location of remote controller, the real room temperature and the this displayed value can be different

• 5°C is proper for the difference between room and outside temperature.

Sub Function - Plasma Purification(Accessory)

Only products with humidifying function can use this.

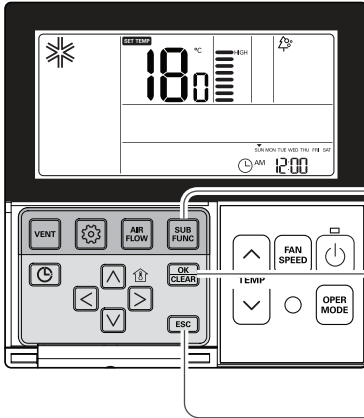

The method to setup cleaning air

- 1 Repeat pressing **SUB FUNC** button until icon flash.
- 2 Operate or cancel Plasma Purification function by pressing **OK/CLEAR** button. (icon appears/disappears on **SUB FUNCTION** display part up to selection)
- 3 After setting, press **ESC** button to exit.

- * After setup, it automatically gets out of setup mode if there is no button input for 25 seconds.
- * When exiting without pressing set button, the manipulated value is not reflected.

- Cleaning air function is additional function and it might not be indicated or operated at the partial product.
- Cleaning air function is possible only when product is running.
- If you want independent cleaning air drive, please setup cleaning air by pressing additional drive button at ventilation drive.
- * Some functions may not be operated and displayed depending on the product type.

Sub Function - Comfort Cooling

The comfort cooling is the function to automatically control the cooling strength to maintain the pleasant feeling without turning off the product after the indoor temperature reached the desired temperature.

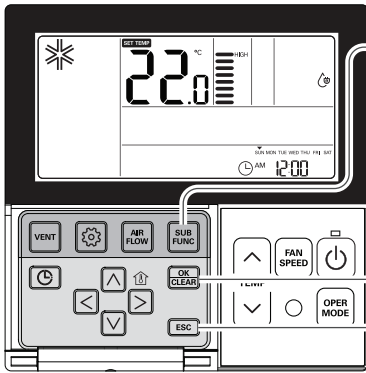

1 Press **SUB FUNC** button repeatedly until Comfort cooling icon displayed.

2 Turn on/off Comfort cooling function by pressing **OK CLEAR** button.
* The icon will be displayed in case of setting option and disappear in reverse case.

3 Press **ESC** button after setup.
* If no button is selected for about 25 seconds after setup, it exits the setup mode
* If the **OK CLEAR** button is not selected before you exit, the changes will not apply.

* Some products may not include Comfort cooling function.

Function Setting - Child Lock

It is the function to use preventing children or others from careless using.

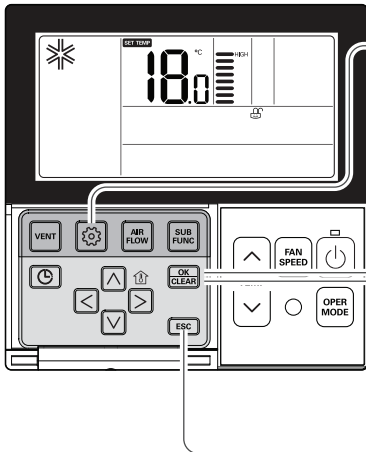

1 Press button repeatedly until the is flashing.

2 If moving to 'setup' icon area by using **<** **>** button, 'setup' icon blinks, and child lock function is setup if pressing **OK CLEAR** button at that time.



3 When cancelling lock function, if moving to 'cancel' icon by pressing **<** **>** button and then, pressing **OK CLEAR** button, child lock function is cancelled.



4 Press **ESC** button to exit.
* After setup, it automatically gets out of setup mode if there is no button input for 25 seconds.
* When exiting without pressing set button, the manipulated value is not reflected.

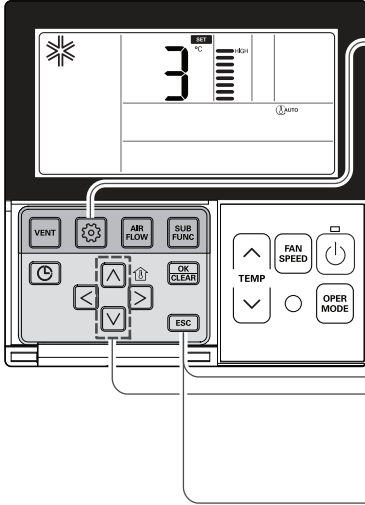

Function Setting - Change Temp



Change temperature is the function to setup air-cooling and heating drive automatically changeable according to the temperature at artificial intelligence drive mode.





- 1** Repeat pressing  button until  icon flash.



- 2** Press   button to change.
 * Converting temp value : 1~7

 → 

- 3** Press  button to complete and active the setting process.





- 4** Press  button to exit or system will automatically release without any input after 25 seconds.
 * When exiting without pressing set button, the manipulated value is not reflected.

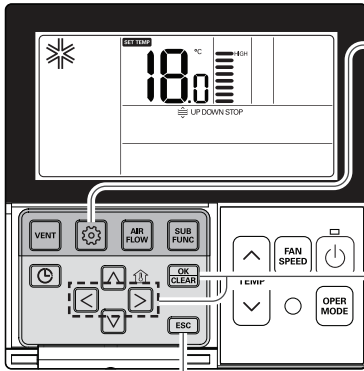

Function Setting - Elevation Grill(Accessory)

This function is to move the indoor filter up/down for cleaning filter.



- 1 Press button
Repeat pressing button until icon flash.
- 2 Move to descent using button and press button will display descent icon and the up/down grill will descent.
- 3 When up/down grill descends to the desired position, move to stop icon using button and press button to stop up/down grill.
- 4 When filter cleaning is finished, fix the filter to the up/down grill, move to ascent icon using button, and press button to ascent up/down grill.
- 5 Press button to exit.
 * After setup, it automatically gets out of setup mode if there is no button input for 60 seconds.
 * When exiting without pressing set button, the manipulated value is not reflected.

- Elevation grill function only operates in the indoor unit with the elevation grill.
- * Some functions may not be operated and displayed depending on the product type.

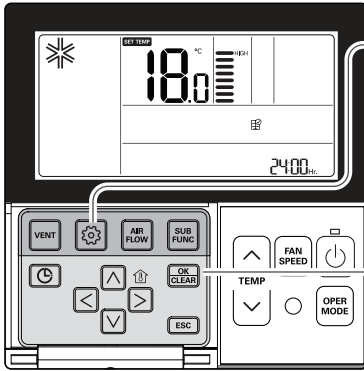

Function Setting - Filter Sign Clear

This function is to clear the indicator of indoor filter cleaning.



1 Press  button repeatedly until the  is flashing.



2 When the  is flashing, press the  to clear this display



- When filter is covered by dust, it will reduce cooling/heating efficiency and accumulate more electric power. Therefore, do clean the filter whenever cleaning time is expired.









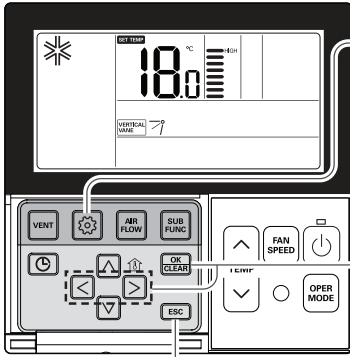







* Filter cleaning indication is automatically cancelled without the separate cancellation after certain period of time.

Function Setting - Vane Angle Control

This function is to adjust angle at which airflow is blow out.

* Some functions may not be operated and displayed depending on the product type.



- 1 Repeat pressing  button until  icon flash. 
- 2 Press   button to select active vane : 1 / 2 / 3 / 4 / All / Standard
Select Vane number using   buttons.
* Vane number : No. 1, 2., 3, 4, all, or standard
 - Selected vane is in operation.
 - Please verify the operating vane.
 - To set the angle of all the vanes, select 'all'.
 - To set as the factory default settings, select 'standard'.
- 3 Select wind angle using   button, and press  button.
 - The boundary of wind angle settings can be changed to 5 levels or 6 levels according to the product.
 - When selecting 'standard' for Vane number, the wind angle does not move.
- 4 Set the wind angles for the remaining vanes as the same as above.
* There are products with vanes with no. 1 and no. 2 only according to the product types.
- 5 Press  button to exit. 
 - * After setup, it automatically gets out of setup mode if there is no button input for 60 seconds.
 - * When exiting without pressing set button, the manipulated value is not reflected.
- 6 Press  button to complete and active the setting process. (Airflow direction function will be released whenever setting vane angle) 
- 7 Press  button to exit or system will automatically release without any input after 25 seconds. 

Function Setting - Changing Current Time

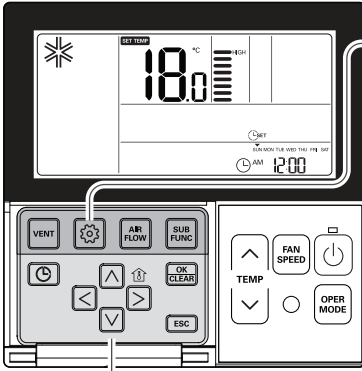

- 1** Please press function setup button. If pressing function setup button repeatedly, it moves to time setup menu. 'Time setup' icon is indicated at that time and date blinks at current time indication area.

Ex) Changing Current Time as 'Monday / AM 10:20'.

- 2** Press key to adjust the current day.



- 3** Press key to move to AM/ PM setting mode (the 'AM/ PM' segment will flash).



- 4** Setting AM/ PM value by pressing button.



- 5** Press button to move to 'Hour' setting mode. (the 'Hour' segment will flash)



- 6** Setting Hour value by pressing button.



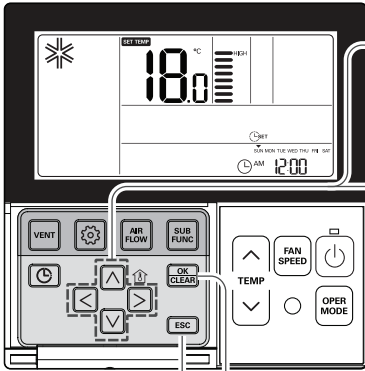

- 7 Press button to move to 'Minute' setting mode. (the 'Minute' segment will flash)



- 8 Setting Minute value by pressing button.



- 9 Press button to finish.



- 10 In the process, press button to release and exit from setting mode. (In case of exit with incomplete information, it will return to the previous setting)



* When exiting without pressing set button, the manipulated value is not reflected.

Programming - Simple Reservation

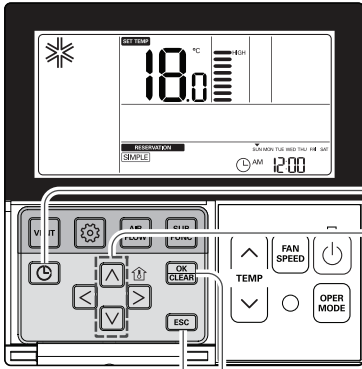

You can set the reservation conveniently in the units of 1 hour from 1 hour to 7 hours.





- 1** Press  button to enter the Programming mode.
(the **SIMPLE** segment flashing)

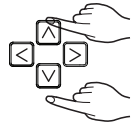

Ex) Setting Simple Reservation time as '3'.

- 2** Press   button to adjust reservation time.



- 3** Press  button to finish setting.



- 4** Press  button to exit.
* After setup, it automatically gets out of setup mode if there is no button input for 25 seconds.
* When exiting without pressing set button, the manipulated value is not reflected.

* When simple reservation setup, product automatically runs or stops after the time that is set.

Programming - Weekly Reservation

You can set the daily reservation in weekly unit.

Weekly reservation keeps operating until before you cancel it once you setup.

- 1** Please move to reservation setup mode by pressing reservation button.
 * You can setup two weekly reservations for one day, and up to fourteen reservations for a week.
 For example, to setup (Tuesday morning 11:30 turned on ~ afternoon 12:30 turned off), you setup in order below.

- 2** Please move to 'weekly' by repeatedly pressing reservation button. 'Weekly' blinks at this time.

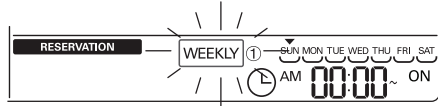

- 3** Please select weekly reservation or weekly reservation ①② by using button.
 * You can setup two reservations, weekly reservation 1 and weekly reservation 2, for a day.

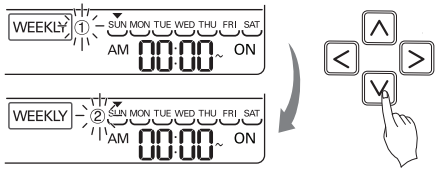

- 4** Please move to 'date' setup part by using button. If 'date' indication blinks, please setup date. You can setup date from Monday to Sunday.

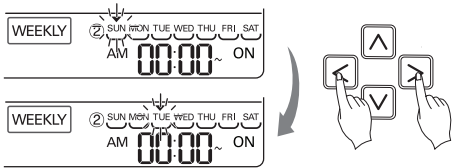

- 5** Please move to 'AM/PM' setup part of turning on by using button.

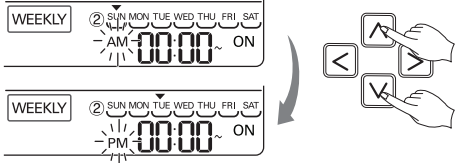

- 6** Please move to 'hour' setup part of turning on by using button.
 - It is the part to setup the time at which air-conditioner is turned on.

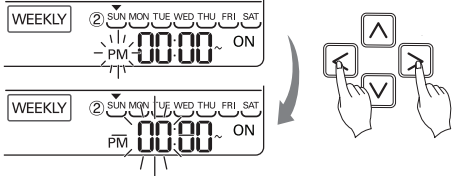

- 7** Please change time by using button.
 - You can setup hour 0~12.

- 8** Please move to 'minute' setup part of turning on by using button.

- 9** If 'minute' indication blinks, please setup 'minute' by using button

10 Please move to 'AM/PM' setup part of turning off by using  button.
 - AM/PM setup is identical with turning on time setup.

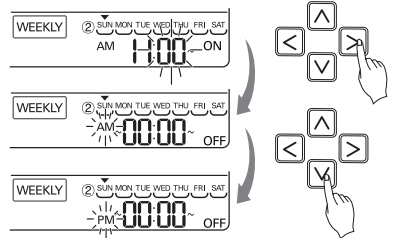

11 Please move to 'hour' setup part of turning off by using Right button.
 - It is the part to reserve the time at which air-conditioner is turned off.
 - If 'hour' indication blinks, please setup 'hour'.
 ※ Please setup 'hour' and 'minute' identically with the method to setup turning on time.

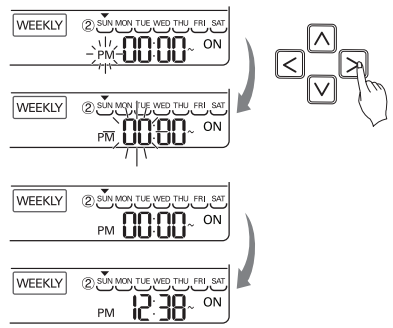

12 If finishing weekly reservation setup, please press setup/cancellation button. Weekly reservation setup for the day that you set is finished.

13 If you setup with the method identical with above by selecting the day that you'd like to setup, it operates weekly reservation.
 If you setup both turning on reservation time and turning off reservation time identically, it doesn't operate reservation drive.

Weekly reservation explanation

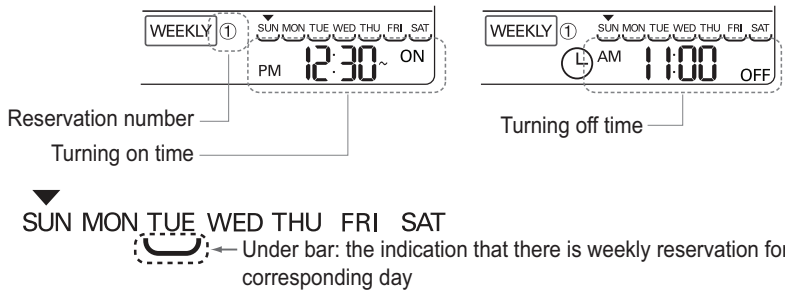

* Indoor unit is turned on to desired temperature if it is configured using up/down button during preset of weekly operation time.
 - When desired temperature is not set, it is turned on automatically with desired temperature of previous operation.

Programming - Sleep Reservation

Sleep reservation is the function of air-conditioner to run and stop after certain period of time at sleep mode before sleep. When connected to a ventilation product and set the sleep reservation, when it goes to the sleep mode, after the set time has elapsed.

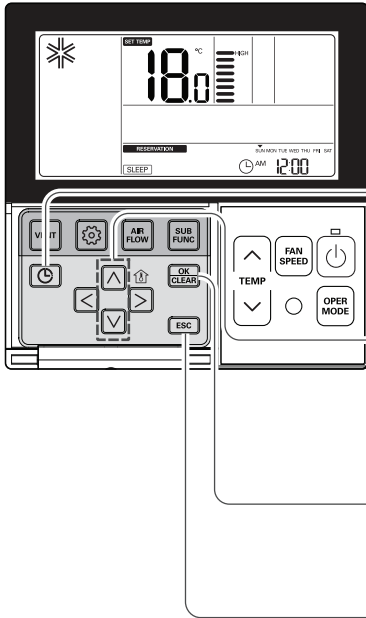

1 Press button to enter the Programming mode.
Ex) Setting Sleep Reservation time as '3'.



2 Repeat pressing button to enter the SLEEP reservation setting mode.
(segment flashing)

3 Press button to adjust reservation time.
The SLEEP reservation time is from 1 to 7 hours.

→

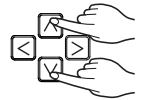

4 Press button to finish setting.
Whenever reservation is done.



5 Press button to exit.
* After setup, it automatically gets out of setup mode if there is no button input for 60 seconds.
* When exiting without pressing set button, the manipulated value is not reflected.
- If reservation is setup, 'sleep' indication shows up at the lower part of LCD screen.

6 If finishing sleep reservation setup, air-conditioner product operates sleep drive and stops after the time that is set.

CAUTION

Please reserve proper time at sleeping. (Too much air-cooling is not good for your health.)

- Because it automatically adjusts desired temperature for comfortable air-cooling at sleep drive, there could be difference between remote controller's desired temperature and air-conditioner body's desired temperature.
- Sleep reservation operates as off reservation for the product whose temperature adjustment isn't controlled by unit of 0.5°C.

Programming - ON Reservation

Automatically turned On at reserved time that you set.

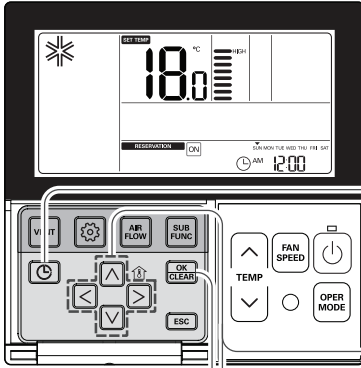

1 Press button.

Ex) Setting ON Reservation Time as 'AM 10:20'.



2 Repeat pressing button to enter the ON reservation setting mode.
(segment flashing)



3 Press button to adjust AM/ PM setting.

AM ~ 12:00



4 Press button to Hour setting mode. When the Hour icon flash, please setting time.
The setting range is within 1~12.

AM ~ 12:00



AM ~ 10:00



5 Press button to shift to Minute setting mode. When the Minute icon flash, please setting minute the setting range is within 00~59.

AM ~ 10:00



AM ~ 10:20



6 Press button to finish setting.

AM ~ 10:20



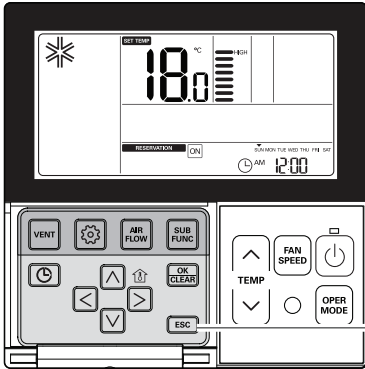

- 7** Press **ESC** button to exit.
- * After setup, it automatically gets out of setup mode if there is no button input for 25 seconds.
 - * When exiting without pressing set button, the manipulated value is not reflected.
 - If reservation is set, 'turned on' indication shows up at the lower part of LCD screen, and air-conditioner product runs at the time that is set.
 - If reservation is cancelled, 'turned on' indication disappears.

Programming - OFF Reservation

Automatically turned Off at reserved time that you set.

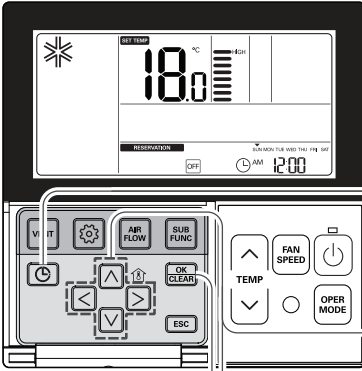

1 Press button.
Ex) Setting OFF Reservation Time as 'AM 10:20'.

2 Repeatedly pressing button to enter the OFF reservation setting mode.
(segment flashing)

3 Press button to adjust AM/ PM setting.



4 Press button to shift to Hour setting mode. When the Hour icon flash, please setting time.
The setting range is within 1~12.



5 Press button to shift to Minute setting mode. When the Minute icon flash, please setting minute the setting range is within 00~59.



6 Press button to finish setting.



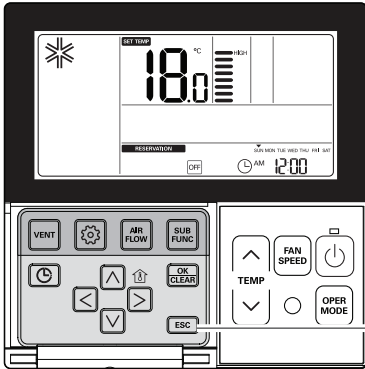



- 7** Press **ESC** button to exit.
- * After setup, it automatically gets out of setup mode if there is no button input for 25 seconds.
 - * When exiting without pressing set button, the manipulated value is not reflected.
 - If reservation is set, 'turned off' indication shows up at the lower part of LCD screen, and air-conditioner product runs at the time that is set.
 - If reservation is cancelled, 'turned off' indication disappears.

Programming - Holiday Reservation

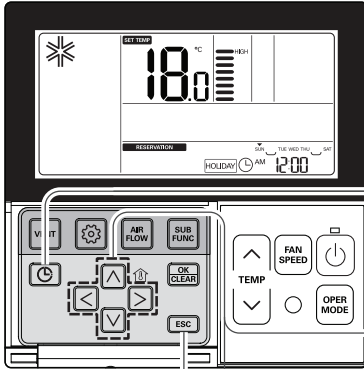
It automatically stops at reserved day that you set.





- 1** Please press  button.
It enters into reservation setup mode.





- 2** Please move to 'holiday' by repeatedly pressing  button.

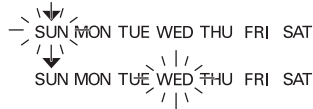

- 3** Please move to 'date' that you want to setup holiday by using   button.



- 4** Please appoint or cancel holiday by using   or  button.
For example, when you setup Monday/Friday to holiday
- 'Monday', 'Friday' letter disappears.



- 5** Please press  button if finishing holiday setup.

* If it comes to appointed holiday, air-conditioner automatically stops.
Once you setup holiday appointment, until before you cancel holiday setup, air-conditioner automatically stops within one hour even though you run air-conditioner.

MAINTENANCE AND SERVICE

! CAUTION

Before performing any maintenance, turn off the main power to the system.

Indoor Unit

Grille, Case and Remote Control

- Turn the system off before cleaning. To clean, wipe with a soft, dry cloth. Do not use bleach or abrasives.

! NOTE

Supply power must be disconnected before cleaning the indoor unit.

Air Filters

The air filters behind the front grille should be checked and cleaned once every 2 weeks or more often if necessary.

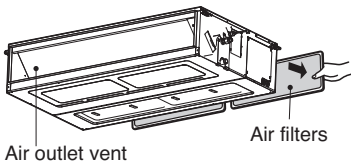

- Never use any of the followings:
 - Water hotter than 40°C.
 - Could cause deformation and/or discoloration.
 - Volatile substances.
 - Could damage the surfaces of the air conditioner.



- 1 Remove the Air filters.
 - Take hold of the tab and pull slightly forward to remove the filter.

! CAUTION

When the air filter is to be removed, do not touch the metal parts of the indoor unit. **It may cause an injury.**

- 2 Clean dirt from the air filter using a vacuum cleaner or washing with water.
 - If dirt is conspicuous, wash with a neutral detergent in lukewarm water.
 - If hot water (50°C or more) is used, it may be deformed.
- 3 After washing with water, dry well in the shade.
 - Do not expose the air filter to direct sunlight or heat from a fire when drying it.
- 4 Install the air filter.

Purifying filter(Optional)

Cleaning

The PLASMA filter behind the air filters should be checked and cleaned once every 3 months or more often if necessary.

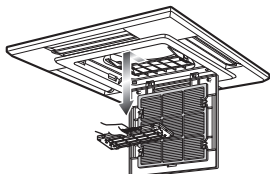

- 1 After removing the air filters, pull slightly forward to remove the PLASMA filter.
- 2 Dip the PLASMA filter into the water mixed with neutral detergent, for 20~30 minutes.
- 3 Dry the PLASMA filter in the shade for a day (Especially, the humidity must be removed perfectly on this parts).
- 4 Note the cuts of electric discharge lines.
- 5 Re-install the PLASMA filter to the original position.



CAUTION

Don't touch this PLASMA Filter within 10 seconds after opening the inlet grille, it may cause an electric shock.

Replacement

- Recommended use period : About 2 years

- 1 Open front panel and remove air filter.

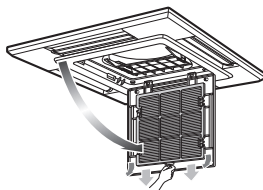

- 2 Remove air purifying filter.
- 3 Insert new air purifying filter.

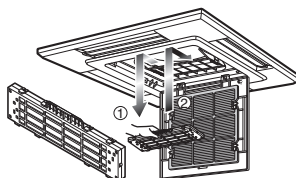

- 4 Reinsert air filter and close front panel.

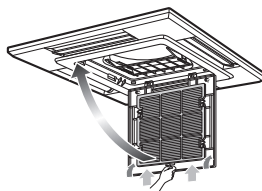

Operation Tips!

<p>Do not overcool the room. This is not good for the health and wastes electricity.</p>	<p>Keep blinds or curtains closed. Do not let direct sunshine enter the room when the air conditioner is in operation.</p>	<p>Keep the room temperature uniform. Adjust the vertical and horizontal airflow direction to ensure a uniform temperature in the room.</p>
<p>Make sure that the doors and windows are shut tight. Avoid opening doors and windows as much as possible to keep the cool air in the room.</p>	<p>Clean the air filter regularly. Blockages in the air filter reduce the airflow and lower cooling and dehumidifying effects. Clean at least once every two weeks.</p>	<p>Ventilate the room occasionally. Since windows are kept closed, it is a good idea to open them and ventilate the room now and then.</p>

When the air conditioner is not going....

When air conditioner is not going to be used for a long time.

- 1 Operate the air conditioner at the following settings for 2 to 3 hours.
 - Type of operation: Fan operation mode.
 - This will dry out the internal mechanisms.
- 2 Turn off the breaker.



CAUTION

Turn off the breaker when the air conditioner is not going to be used for a long time. Dirt may collect and may cause a fire.

- 3 Remove the batteries from the Remote Controller.

Helpful information

The air filters and your electric bill.

If the air filters become clogged with dust, the cooling capacity will drop, and 6% of the electricity used to operate the air conditioner will be wasted.

When the air conditioner is to be used again.

- 1 Clean the air filter and install it in the indoor unit.
- 2 Check that the air inlet and outlet of the indoor/outdoor unit are not blocked.
- 3 Check that the ground wire is connected correctly. It may be connect to the indoor unit side.

Troubleshooting Tips! Save time and money!

Check the following points before requesting repairs or service.... If the malfunction persist, please contact your dealer.

Case	Explanation
The air conditioner does not operate.	• Have you made a mistake in timer operation?
	• Has the fuse blown or has the circuit breaker been tripped?
The room has a peculiar odor.	• Check that this is not a damp smell exuded by the walls, carpet, furniture or cloth items in the room.
It seems that condensation is leaking from the air conditioner.	• Condensation occurs when the airflow from the air conditioner cools the warm room air.
Air conditioner does not operate for about 3 minutes when restart.	• This is the protector of the mechanism.
	• Wait about three minutes and operation will begin.
Does not cool or heat effectively.	• Is the air filter dirty? See air filter cleaning instructions.
	• The room may have been very hot when the room air conditioner was first turned on. Allow time for it to cool down.
	• Has the setting temperature been set incorrectly?
	• Are the indoor unit's air inlet or outlet vents obstructed?
The air conditioner operation is noisy.	• For a noise that sounds like water flowing. -This is the sound of freon flowing inside the air conditioner unit.
	• For a noise that sounds like the compressed air releasing into atmosphere. -This is the sound of the dehumidifying water being processed inside the air conditioning unit.
Crack sound is heard.	• This sound is generated by the expansion/contraction of the inlet grille, etc. due to changes of temperature.
Filter sign lamp (LED) is ON.	• Cleaning the filter, press the Timer button and ◀ button of wired remote controller at the same time for 3 seconds.
Remote control display is faint, or no display at all.	• Has the circuit breaker been tripped?
	• Are the batteries inserted in the opposite (+) and (-) directions?
The error code is occurred after lightning struck	• This product has been applied to the over current protection circuit. Error can occur, but it is normal behavior. After few minutes, It will operate normally.

Call the service immediately in the following situations

- Anything abnormal such as burning smell, loud noise etc. happen. Stop the unit and turn the breaker off. Never try to repair by yourself or restart the system in such cases.
- Main power cord is too hot or damaged.
- Error code is generated by self diagnosis.
- Water leaks from indoor unit even if the humidity is low.
- Any switch, breaker (safety, earth) or fuse fails to work properly

User must carry routine checkup & cleaning to avoid unit's poor performance.

In case of special situation, the job must be carried out by service person only.

